

Series PVD33N

Microelectronic Power IC
HEXFET® Power MOSFET Photovoltaic Relay
Single-Pole, Normally-Open
0-300V DC, 240mA

General Description

The PVD33 Series DC Relay (PVD) is a single-pole, normally open, solid-state replacement for electromechanical relays used for general purpose switching of analog signals. It utilizes International Rectifier's HEXFET power MOSFET as the output switch, driven by an integrated circuit photovoltaic generator of novel construction. The output switch is controlled by radiation from a GaAlAs light emitting diode (LED), which is optically isolated from the photovoltaic generator.

The PVD33 Series overcomes the limitations of both conventional electromechanical and reed relays by offering the solid state advantages of long life, fast operating speed, low pick up power, bounce-free operation, low thermal offset voltages and miniature package. These advantages allow product improvement and design innovations in many applications such as process control, multiplexing, automatic test equipment and data acquisition.

The PVD33 can switch analog signals from thermocouple level to 300 Volts peak DC. Signal frequencies into the RF range are easily controlled and switching rates up to 500Hz are achievable. The extremely small thermally generated offset voltages allow increased measurement accuracies.

These relays are packaged in 8-pin, molded DIP packages and available with either thru-hole or surface-mount ("gull-wing") leads, in plastic shipping tubes.

Applications

- Process Control
- Data Acquisition
- Test Equipment
- Multiplexing and Scanning

Features

- Bounce-Free Operation
- 10^{10} Off-State Resistance
- 1,000 V/ μ sec dv/dt
- 5 mA Input Sensitivity
- 4,000 V_{RMS} I/O Isolation
- Solid-State Reliability
- UL Recognized
- ESD Tolerance:
 - 4000V Human Body Model
 - 500V Machine Model

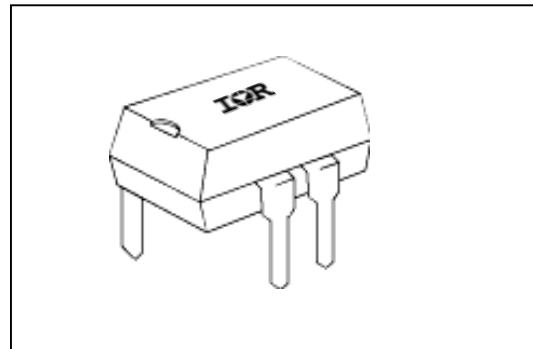

Part Identification

PVD2352N	
PVD3354N	thru-hole
PVD2352NS	surface-mount
PVD3354NS	(gull-wing)

(HEXFET is the registered trademark for International Rectifier Power MOSFETs)

Series PVD33N

International
IR Rectifier

Electrical Specifications (-40°C ≤ T_A ≤ +85°C unless otherwise specified)

INPUT CHARACTERISTICS	PVD2352N	PVD3354N	Units
Minimum Control Current (see figures 1 and 2) For 250mA Continuous Load Current For 240mA Continuous Load Current For 200mA Continuous Load Current	2 5 5		DC mA@25°C mA@40°C mA@85°C
Maximum Control Current for Off-State Resistance at 25°C	10		µA(DC)
Control Current Range (Caution: current limit input LED. See figure 6)	2.0 to 25		mA(DC)
Maximum Reverse Voltage	7.0		V(DC)

OUTPUT CHARACTERISTICS	PVD2352N	PVD3354N	Units
Operating Voltage Range	200	300	V _(peak)
Maximum Load Current 40°C I LED 5mA	240		mA(DC)
Response Time @25°C (see figures 7 and 8) Max. T _(on) @ 12mA Control, 50 mA Load, 100 VDC Max. T _(off) @ 12mA Control, 50 mA Load, 100 VDC	100 110		µs µs
Max. On-state Resistance 25°C (Pulsed) (fig. 4) 50 mA Load, 5mA Control	6		Ω
Min. Off-state Resistance 25°C (see figure 5)	10 ⁸ @ 160VDC	10 ¹⁰ @ 240VDC	Ω
Max. Thermal Offset Voltage @ 5.0mA Control	0.2		µvolts
Min. Off-State dv/dt	1000		V/µs
Typical Output Capacitance (see figure 9)	10		pF @ 50VDC

GENERAL CHARACTERISTICS	(PVD2352N and PVD3354N)	Units
Dielectric Strength: Input-Output	4000	V _{RMS}
Insulation Resistance: Input-Output @ 90V _{DC}	10 ¹² @ 25°C - 50% RH	Ω
Maximum Capacitance: Input-Output	1.0	pF
Max. Pin Soldering Temperature (1.6mm below seating plane, 10 seconds max.)	+260	°C
Ambient Temperature Range:	Operating Storage	

International Rectifier does not recommend the use of this product in aerospace, avionics, military or life support applications. Users of this International Rectifier product in such applications assume all risks of such use and indemnify International Rectifier against all damages resulting from such use.

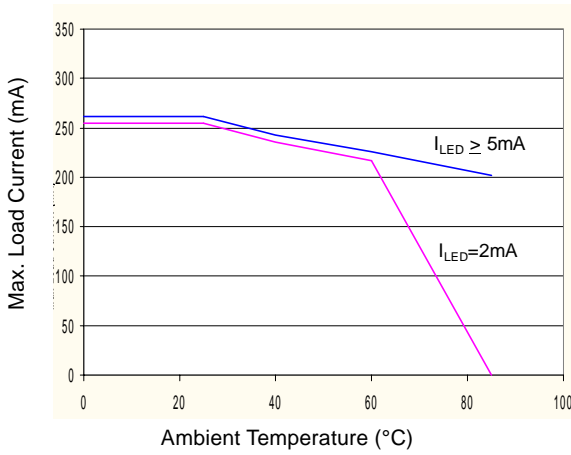

Figure 1. Current Derating Curves

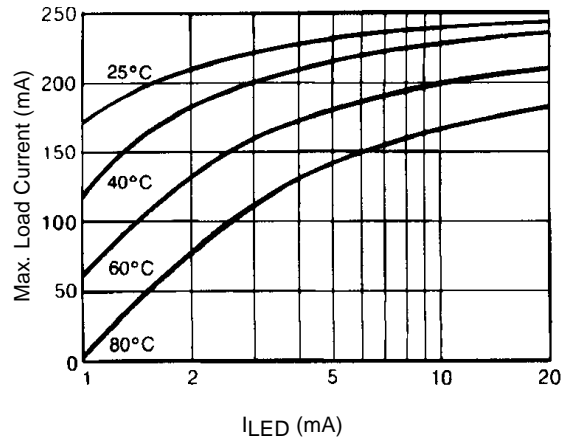

Figure 2. Typical Control Current Requirements

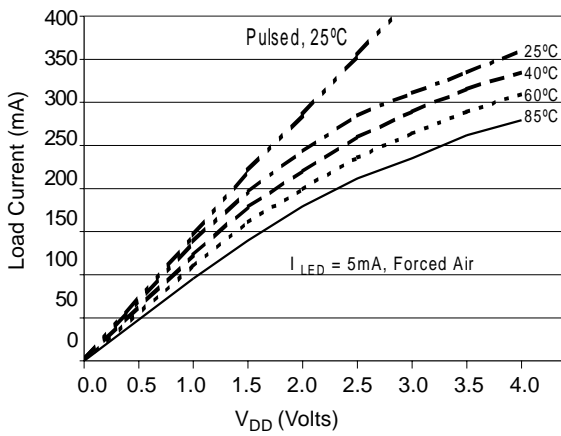

Figure 3. Typical On Characteristics

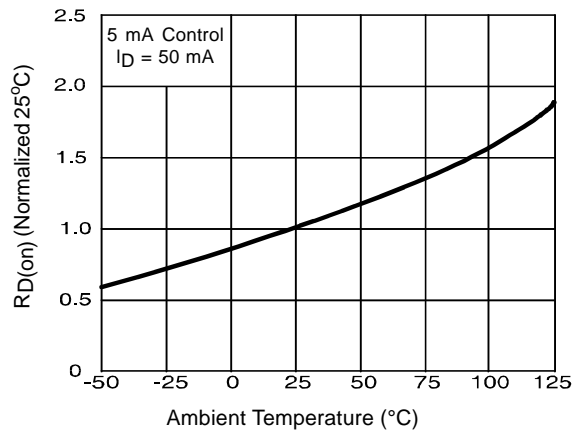

Figure 4. Typical On-Resistance

Series PVD33N

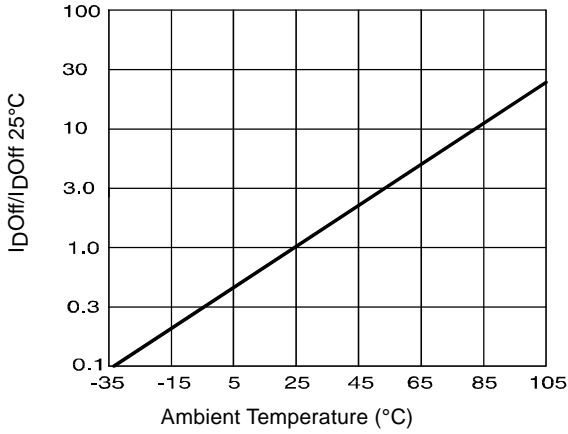

Figure 5. Normalized Off-State Leakage

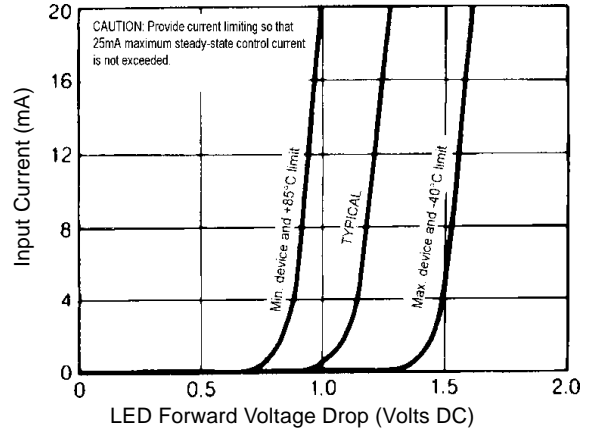

Figure 6. Input Characteristics (Current Controlled)

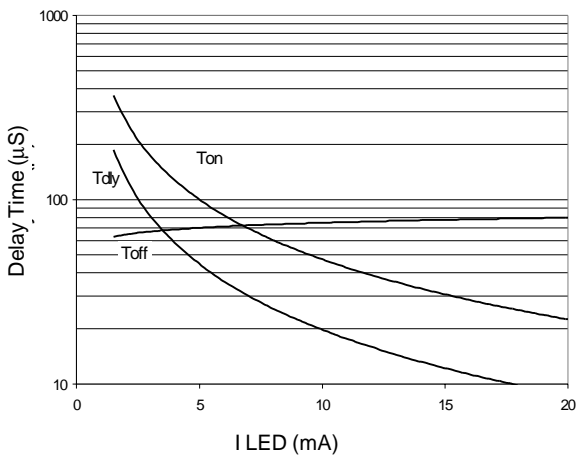

Figure 7. Typical Delay Times

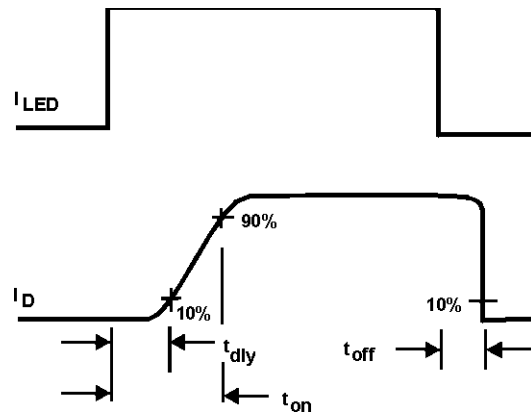

Figure 8. Delay Time Definitions

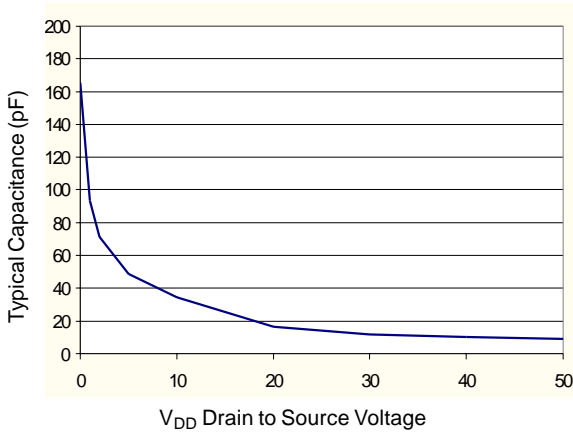
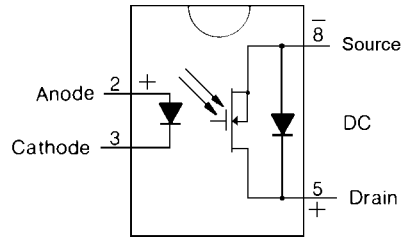
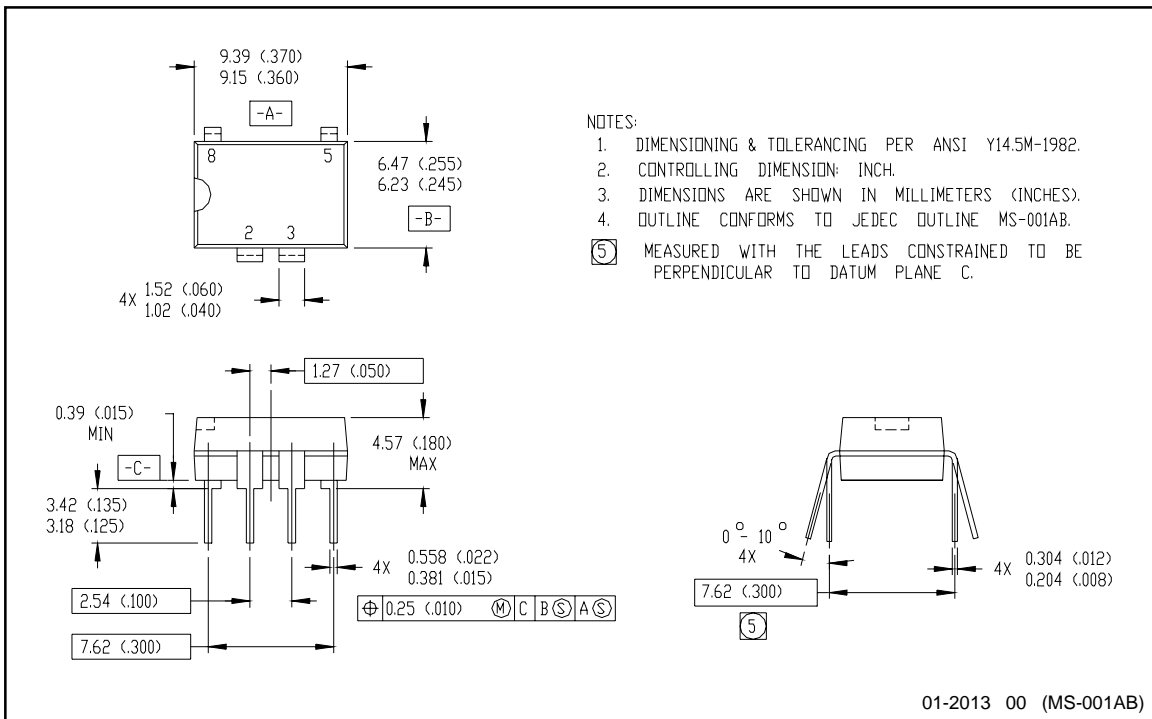

Figure 9. Typical Output Capacitance

Wiring Diagram



Case Outline



Case Outline

